

Decoupling Caps

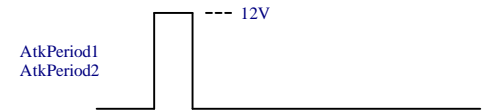

All signals: Vmin = 0V

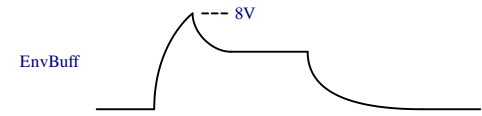
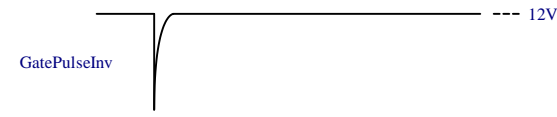
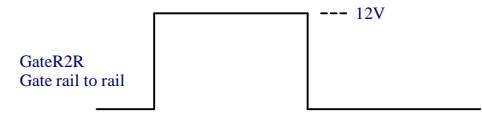
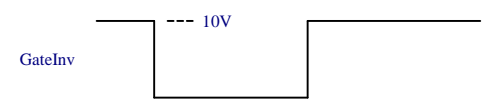
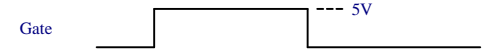
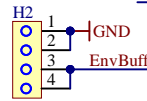
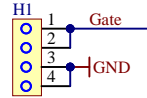
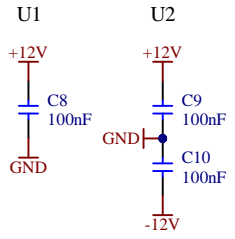
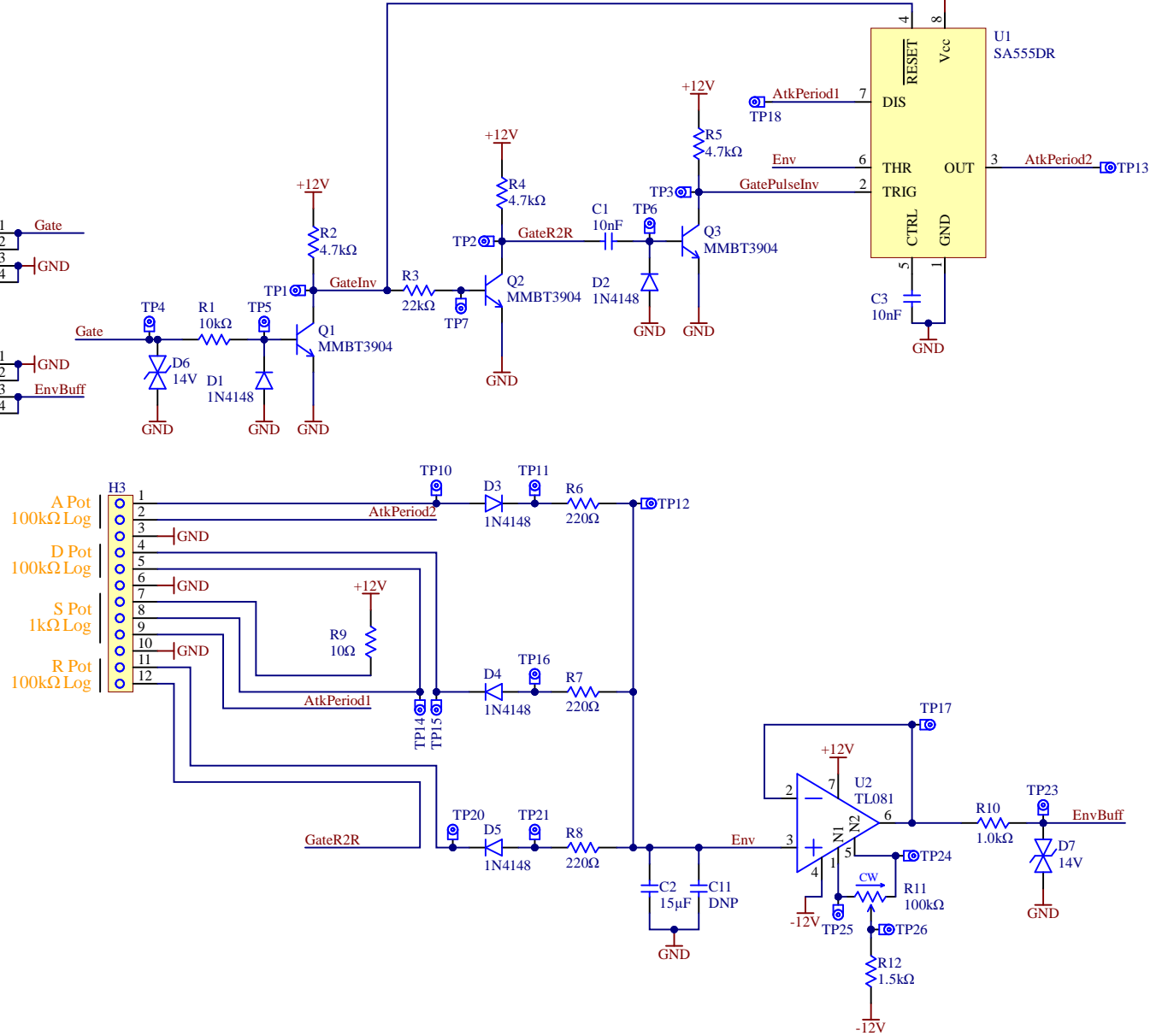
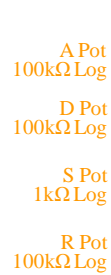

Derived from an ADSR design by Rene Schmitz from 1999
schmitzbits.de/adsr.html

	Project: ADSR	Date: 20241012
	PCB: ADSR MB	Rev: 2.0
	Sheet:	Sheet: 1 of 1
	ADSR MB - SCH.SchDoc	
		AdamGulyas.ca